



MAHARSHI DAYANAND UNIVERSITY ROHTAK

(A state University established under Haryana Act. No. 25 of 1975)
(NAAC Accredited 'A' Grade)

SPORTS OFFICE



Sports /2019/ 10270-10501
Date:- 23.10.2019

To

All the Principals/Deans/ Directors of Participating,
Colleges/DSW/Institutes affiliated to the University.

Sub: Organization of MDU Inter-College Kabaddi-NS (M), Basketball (W), Volleyball (W), Cricket (W),
Kho-Kho (W), Badminton (W), Rope Skipping (M&W), Boxing (M&W), Archery (M&W),
Judo (M&W), Qwan Ki Do (M&W) and Volleyball (M) Championships, 2019-20.

Sir/Madam,

It is to inform you that the Inter-College(s) of the above mentioned games for Session, 2019-20
will be organized as per schedule & venue given below:

Sr. No.	Name of Inter-College tournament/ championship	Date of Tournament	Date of Selection Trial(s)	Venue
1.	Kabaddi-NS (M)	04-07.11.19	07.11.19 (11AM)	Sports Complex, M.D.U., Rohtak
2.	Basketball (W)	20-22.11.19	22.11.19 (11 AM)	Sports Complex, M.D.U., Rohtak
3.	Volleyball (W)	13-15.11.19	15.11.19 (12 NOON)	Sports Complex, M.D.U., Rohtak
4.	Cricket (W)	12-14.11.19	15.11.19 (10 AM)	Sports Complex, M.D.U., Rohtak
5.	Kho-Kho (W)	07-09.11.19	09.11.19 (11 AM)	Sports Complex, M.D.U., Rohtak
6.	Badminton (W)	05-07.11.19	07.11.19 (1 PM)	Sports Complex, M.D.U., Rohtak
7.	Rope Skipping (M&W)	19-20.11.19	DC	G.C., DUJANA
8.	Boxing (M)	11-12.11.19	DC	C.R.A.College, Sonapat
9.	Boxing (W)	13.11.19	DC	C.R.A.College, Sonapat
10.	Archery (M&W)	26-28.11.19	DC	Agg. Coll., B.garh, Faridabad
11.	Judo (W)	20.11.19	DC	Sports Complex, M.D.U., Rohtak
12.	Judo (M)	21.11.19	DC	Sports Complex, M.D.U., Rohtak
13.	Qwan Ki Do (M&W)	21-23.11.19	DC	Sports Complex, M.D.U., Rohtak
14.	Volleyball (M)	27-29.11.19	DC	Sports Complex, M.D.U., Rohtak

All the Principals/ Deans/ Directors of participating colleges/ Institutes are requested to direct their Asstt/As

so. Prof., Physical Education/In-charge(s) of team to report at above mentioned venue(s) as per Schedule at 09:00 A.M. They will also bring with them the eligibility performa duly signed by competent authority, I-Card of the current session, medical certificate from the participants. The TA/DA, if any and remuneration to the Sel. Committee member(s) will be paid as per MDUSC rules.

Note:

1. Meeting of Officials for Boxing (M&W) Competition will be held on 10.11.19 at 4 PM on said Venue.
2. Medical and Weights for Men Competition will taken on 11.11.19 from 7-9 AM
3. Medical and Weights for Women Competition will taken on 12.11.19 from 4-6 PM

The list of Selection Committee of the above mentioned games is as under:

Kabaddi NS (M)			
1	Dr.Satish Ahuja	Chairperson	Principal, D.A.V. Cent. College Faridabad
2	Dr. Manoj Goel	Member	DAV Cent. Coll. Faridabad
3	Dr. Dinesh	Member	DGC, Gurugram
4	Dr. Balbir Singh Dahiya	Member	GC, Faridabad
5	Game Expert		
6	Secretary MDUSC.		

Basketball(W)			
1	Dr. Suresh Boora	Chairperson	Principal, K.M.V. Kharkhoda
2	Dr. Nitesh Kumar	Member	AIJHM College, Rohtak
3	Dr. Asha Dahiya	Member	S.M. College Palwal
4	Dr. Sunita Choudhary	Member	VAKM, Bahadurgarh
5	Dr. Bindu	Member	Hindu Girls College Sonapat
6	Game Expert		
7	Secretary MDUSC.		

Volleyball(M)			
1	Dr. BK Garg	Chairman	Hindu College, Sonapat
2	Dr. Jyoti Solanki	Member	GC, Faridabad
3	Dr. Vishal	Member	GC, Meham
4	Dr. Amit Chhikara	Member	Govt. College, Bahadurgarh
5	Dr. Jagbir Singh	Member	Aggarwal College Ballabgarh
6	Secretary MDUSC.		

Volleyball(W)			
1	Dr. Jyoti Juneja	Chairman	GVMC, Sonapat
2	Jyoti Solanki	Member	GC, Badli
3	Dr. Sashi Bala	Member	GC, Tigaon, Faridabad
4	Dr. Neetu Sangwan	Member	Hindu Girls College Sonapat
5	Game Expert		
6	Secretary MDUSC.		

Cricket(W)			
1	Dr. Sunita Ahuja	Chairman	DAV Cent. Coll. Faridabad
2	Dr. M.S. Sheoran	Member	Vaish College, Rohtak
3	Mukesh Goel	Member	Sports Office, MDU Rohtak
4	Dr. Hemlata	Member	M.K.J.M., Rohtak
5	Dr. Surjeet Neema	Member	VMM, Rohtak
6	Game Expert		
7	Secretary MDUSC.		

Kho Kho(W)			
1	Dr. Vijay	Chairperson	Principal, Sh. L.N.H. College, Rohtak
2	Dr. Darshna Rani	Member	KM, KHARKHODA
3	Dr. Sandeep Kumar	Member	Govt. College for Women, Gurawara(Rewari)
4	Dr. Rekha Sharma	Member	Hindu Girls College Sonapat
5	Dr. Munni Joon	Member	V.M.M. College, Rohtak
6	Game Expert		
7	Secretary MDUSC.		

Badminton(W)			
1	Dr. Sunita ahuja	Chairperson	D.A.V. Cent. College Faridabad
2	Dr. Jyoti Solanki	Member	GC, Badli

 Director (Sports)
 M.D. University
 ROHTAK

3	Dr. Rachana Gupta	Member	Hindu College, Sonapat
4	Dr. Kamlesh Dhull	Member	Vaish College of Education, Rohtak
5	Sonia	Member	MKJKM, ROHTAK
6	Game Expert		
7	Secretary MDUSC.		

Boxing(W)			
1	Dr. Reshmi Gupta	Chairperson	Principal, VMM, Rohtak
2	Dr. R.P.Garg	Member	Prof. Dept. of Phy. Edu. MDU Rohtak
3	Dr. Nand Kishor	Member	Aggarwal College, Ballabgarh
4	Dr. Surjeet Neema	Member	VMM, Rohtak
5	Dr. Surjeet Neema	Member	VMM, Rohtak
6	Dr. Sukhbir	Member	AIJHM College, Rohtak
7	Game Expert		
8	Secretary MDUSC.		

Boxing(M)			
1	Prof. Randeep Rana	Chairman	Dept. of Eng., MDU, Rohtak
2	Dr. R.P.Garg	Member	Prof. Dept. of Phy. Edu. MDU Rohtak
3	Dr. H.S. Sangwan	Member	GGSDSC, PALWAL
4	Dr. Manoj Kumar	Member	Sports Office, MDU Rohtak
5	Dr. Rammender Hooda	Member	AIJHM College, Rohtak
6	Game Expert		
7	Secretary MDUSC.		

Archery (M&W)			
1	Dr. Krishan Kant, Principal	Chairman	Aggarwal College, Ballabgarh
2	Dr. Narender Kumar	Member	DAV Cen. College Faridabad
3	Dr. Subhash Chander, Judo Coach	Member	Sports Office, MDU Rohtak
4	Dr Mayank	Member	GC, Dubaldhan, Jhajjar
5	Dr. Jagbir Singh	Member	Aggarwal College, Ballabgarh
6	Game Expert		
7	Secretary MDUSC.		

Judo (M)			
1	Dr. Kultaj Singh	Chariperson	Prof. Dept. of Phy. Edu. MDU Rohtak
2	Dr. Basant Kumar	Member	G.C.W, Rohtak
3	Dr. Hemlata	Member	M.K.J.K.M. College, Rohtak
4	Dr. Narender Dhull	Member	AIJHM College, Rohtak
5	Dr. Subhash, Coach	Member	Sports Office, MDU Rohtak
6	Dr. Krishan Kumar	Member	G.B.D. College, Rohtak
7	Dr. Subhash Chander, Judo Coach	Member	Sports Office, MDU Rohtak
8	Secretary MDUSC.		

Judo (W)			
1	Dr. Kultaj Singh	Chariperson	Prof. Dept. of Phy. Edu. MDU Rohtak
2	Dr. Padma Mittal	Member	V.M.M. College, Rohtak

 Director (Sports)
 M.D. University
 ROHTAK

3	Dr. Mukesh Goyat	Member	MKJKM, ROHTAK
4	Dr. Rekha Sharma	Member	Hindu Girls College Sonapat
5	Dr. Subhash Chander, Judo Coach	Member	Sports Office, MDU Rohtak
6	Secretary MDUSC.		

Qwan Ki Do (M&W)			
1	Dr Vikas Siwach	Chairman	UIET, MDU, Rohtak
2	Dr. Titiksha Rohilla	Member	MACW, JHAJJAR
3	Dr. Pardeep Sheoran	Member	LN Hindu College, Rohtak
4	Dr. Vikas	Member	CRA College, Sonapat
5	Dr. Manvinder Gahlawat	Member	UIET, MDU, Rohtak
6	Dr. Dinesh	Member	DGC, Gurugram
7	Dr. Ashok Kumar	Member	Sports Office, MDU Rohtak
8	Game Expert		M.D.U, Rohtak
9	Secretary MDUSC.		

Instructions:

1. Participants will have to submit the risk certificate.
2. Officiating Fee as per MDUSC rules will be paid by the participating College/ Institutes.
3. No team will be allowed to participate without Incharge/ team manager.
4. Trial Fee of Rs. 300/- per student will be charged for selection trials from the concerned College/ Institutes.

Yours sincerely,



Director Sports &
Secretary MDUSC

Endst. No. Sports/2019/_____ Date:- _____

A copy of the above is forwarded to the following for information and necessary action:-

1. President, Sports Executive Board, MDU Rohtak
2. The Director, UCC, MDU Rohtak with the request to upload the same on website inside sport link.
3. Director, Public Relations, MDU Rohtak for wide publicity.
4. Deputy Director Sports, MDU Rohtak
5. Chairman/Chairperson and Members of above mentioned games, 2019-20 with the request to be present at the time of Selection Trial.
6. AR (Sports) MDU Rohtak with the request to depute office staff for officiating and payment of officials for smooth conduct of the tournament.
7. Dealing Assistant/ Clerk, Sports Office, MDU Rohtak for advance and adjustment.

Yours sincerely,

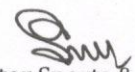

Director Sports &
Secretary MDUSC

FIXTURE OF BALL BADMINTON (M) scheduled at Sports Complex, MDU, RTK

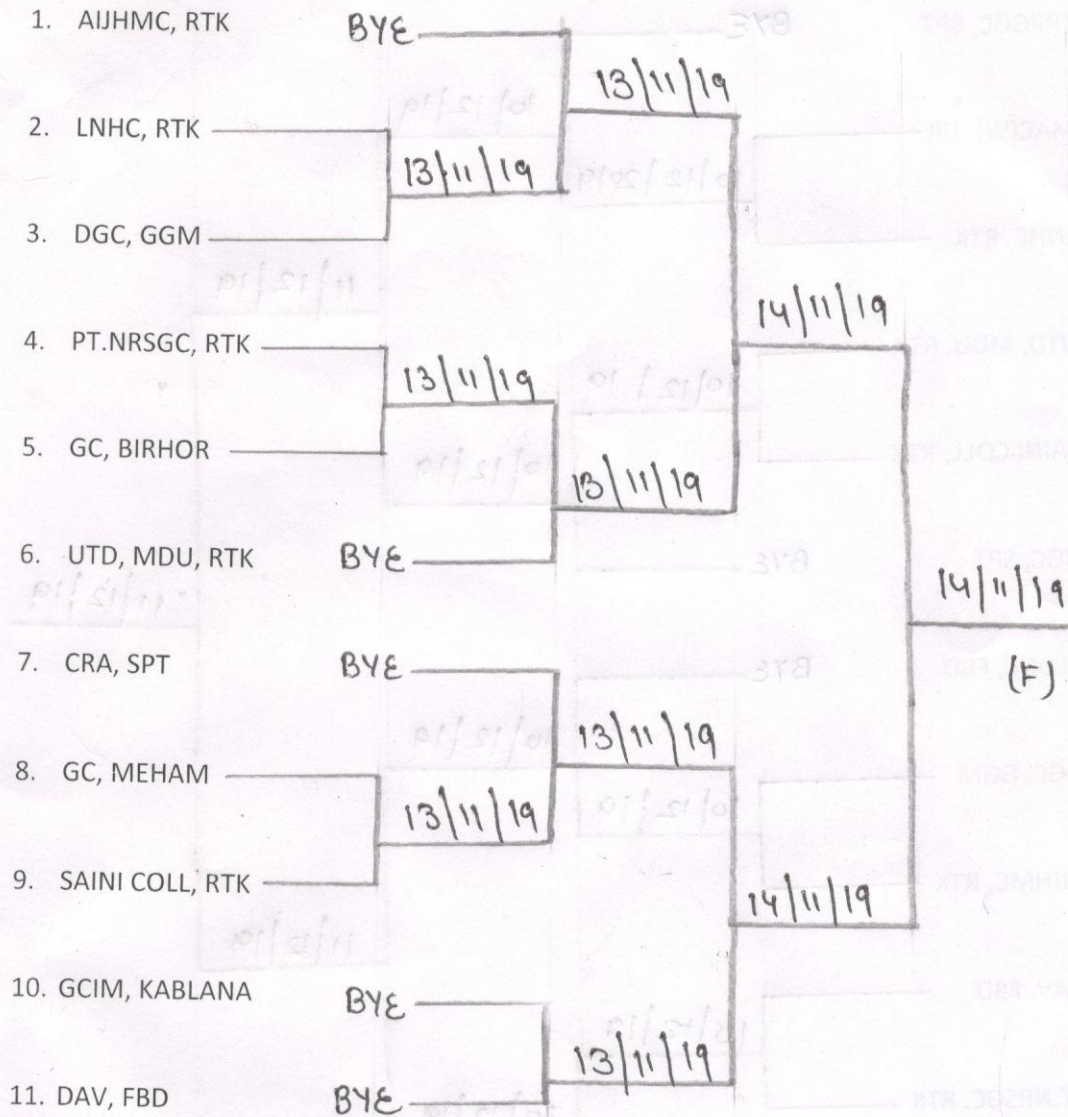

.Match for 3rd & 4th Position will be played on 14.12.19 at 11 Noon.

.Selection trials for Uni. Team on 14.12.19 at 2 PM, Sports Complex, MDU, Rohtak

Shiv
 Director (Sports)
 M.D. University
 ROHTAK

FIXTURE OF BALL BADMINTON (W) scheduled at Sports Complex, MDU, RTK

1. TRPGGC, SPT	BYE		
2. MAC(W), JJR		10/12/19	
3. LNHC, RTK		10/12/2019	
4. UTD, MDU, RTK			11/12/19
5. SAINI COLL, RTK		10/12/19	
6. HGC, SPT	BYE		11/12/19
7. KLDNC, FBD	BYE		
8. DGC, GGM		10/12/19	
9. AIJHMC, RTK		10/12/19	
10. DAV, FBD			11/12/19
11. PT.NRSGC, RTK		10/12/19	
12. MKJKM, RTK	BYE		

.Match for 3rd & 4th Position will be played on 11.12.19 at 12 Noon.

.Selection trials for Uni. Team on 11.12.19 at 2 PM, Sports Complex, MDU, Rohtak

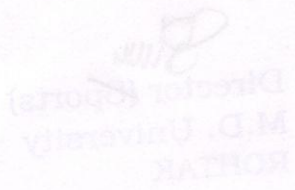

 Director (Sports)
 M.D. University
 ROHTAK

FIXTURE OF CRICKET (W) SCHEDULED AT MDU, RTK

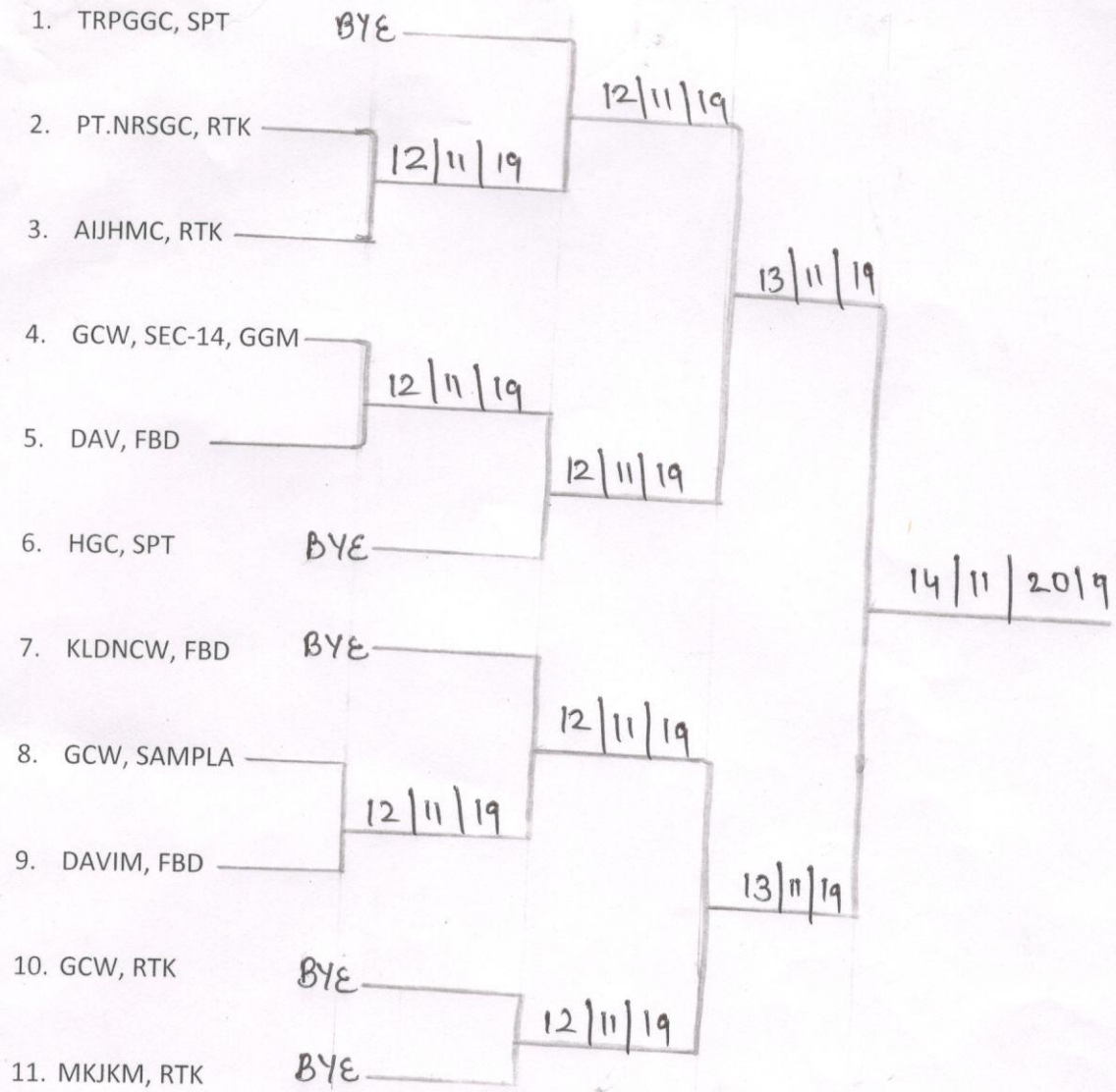

.Match for 3rd & 4th Position will be played on 14.11.19 at 9 AM.

.Selection trials for Uni. Team on 15.12.19 at 10 AM , MDU, RTK

Shy

Director (Sports)
M.D. University
ROHTAK

FIXTURE OF KABADDI (M) SCHEDULED AT MDU, RTK



LEAGUE MATCHES

1. A Vs D - 06.11.19
2. B Vs C - 06.11.19
3. A Vs B - 06.11.19
4. C Vs D - 06.11.19
5. A Vs C - 07.11.19
6. D Vs B - 07.11.19

.Selection trials for Uni. Team on 07.11.19 at 11 AM , MDU, RTK

 Director (Sports)
 M.D. University
 ROHTAK

INTER COLLEGE 2019-20.

FIXTURE OF BASKETBALL (W) SCHEDULED AT MDU, ROHTAK

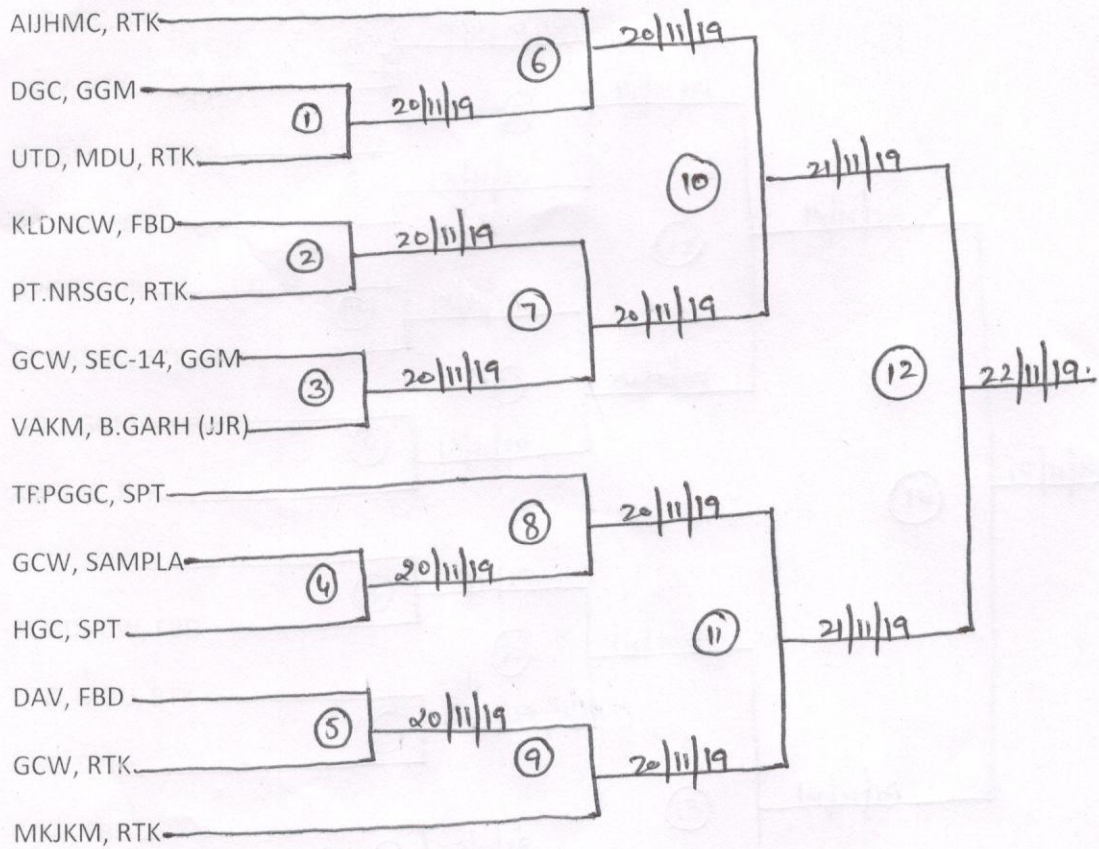

.Match for 3rd & 4th Position will be played on 21.11.19 at 3PM.

.Selection trials for Uni. Team on 22.11.19 at 11 AM, MDU, RTK

Sillu

Director (Sports)
M.D. University
ROHTAK

FIXTURE OF VOLLEYBALL (W) SCHEDULE AT MDU, ROHTAK

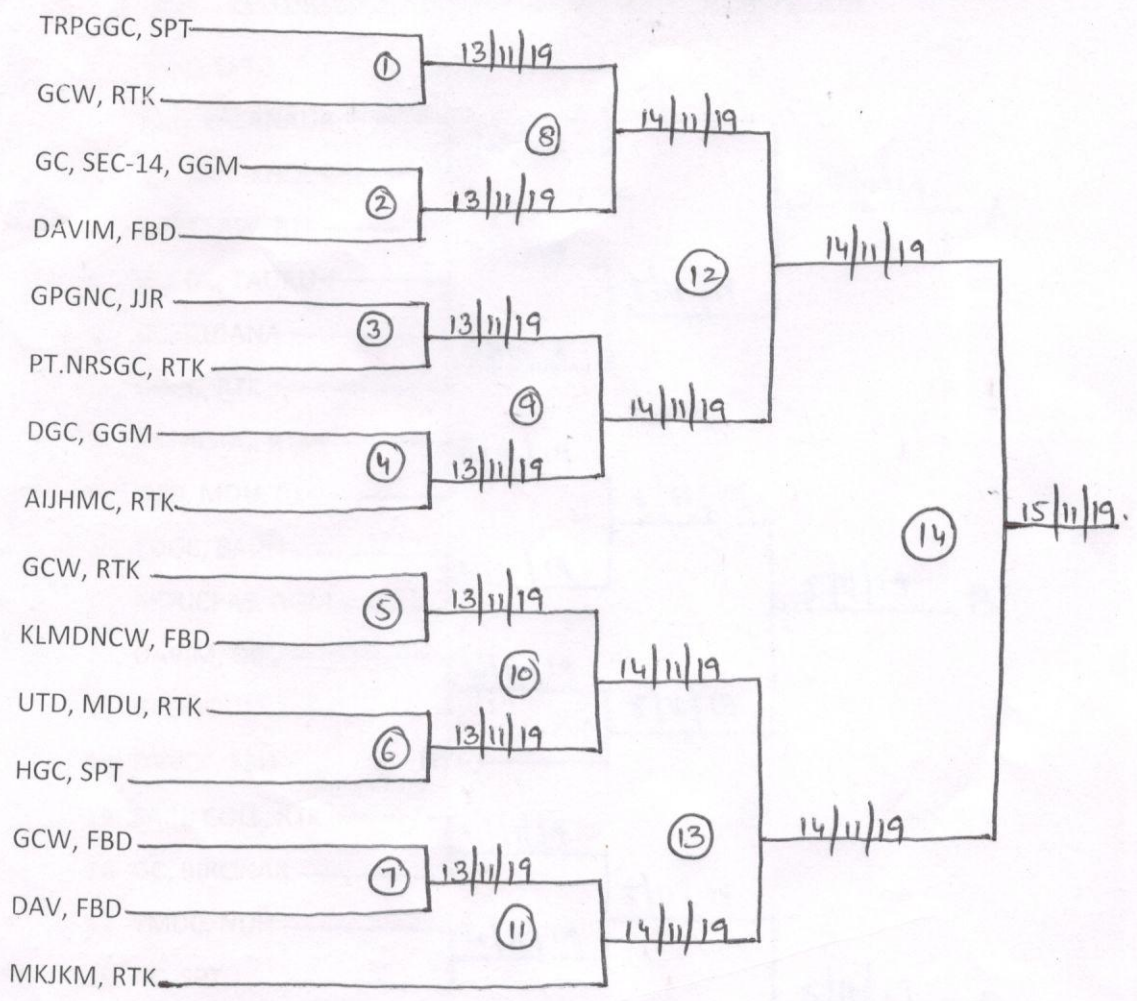

.Match for 3rd & 4th Position will be played on 15.11.19 at 9AM.

.Selection trials for Uni. Team on 15.11.19 at 12 NOON, MDU, RTK

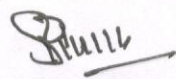
 Director (Sports)
 M.D. University
 ROHTAK

FIXTURE OF VOLLEYBALL (M) SCHEDULED AT MDU, RTK

1. GC, MEHAM	BYE	27/11/19		
2. GPGNC, JJR	BYE		28/11/19	
3. DAVIM, FBD	BYE	27/11/19		
4. UTD, MDU, RTK	BYE			
5. LNHC, RTK	BYE		28/11/19	
6. GC, BIROHAR		27/11/19		
7. YMDC, NUH	27/11/2019 9. AM		28/11/2019	
8. SAINI COLL, RTK	BYE	27/11/19		
9. DGC, GGM	BYE			29/11/2019
10. DAV, FBD	BYE	27/11/19		(F)
11. CDGC, BADLI	BYE		28/11/19	
12. MDUCPAS, GGM		27/11/2019 9. AM		
13. PT.NRSGC, RTK		27/11/19		
14. CRAC, SAMPLA	BYE		28/11/2019	
15. GC, TIGAON	BYE	27/11/19		
16. GITM, KABLANA	BYE		28/11/2019	
17. HLGCC, TAURU	BYE	27/11/19		
18. AIJHMC, RTK	BYE			

.Match for 3rd & 4th Position will be played on 29.11.19 at 9 AM.

.Selection trials for Uni. Team on 29.11.19 at 12 NOON , MDU, RTK

Shw

FIXTURE OF BADMINTON (W) scheduled at SPORTS COMPLEX, MDU, RTK

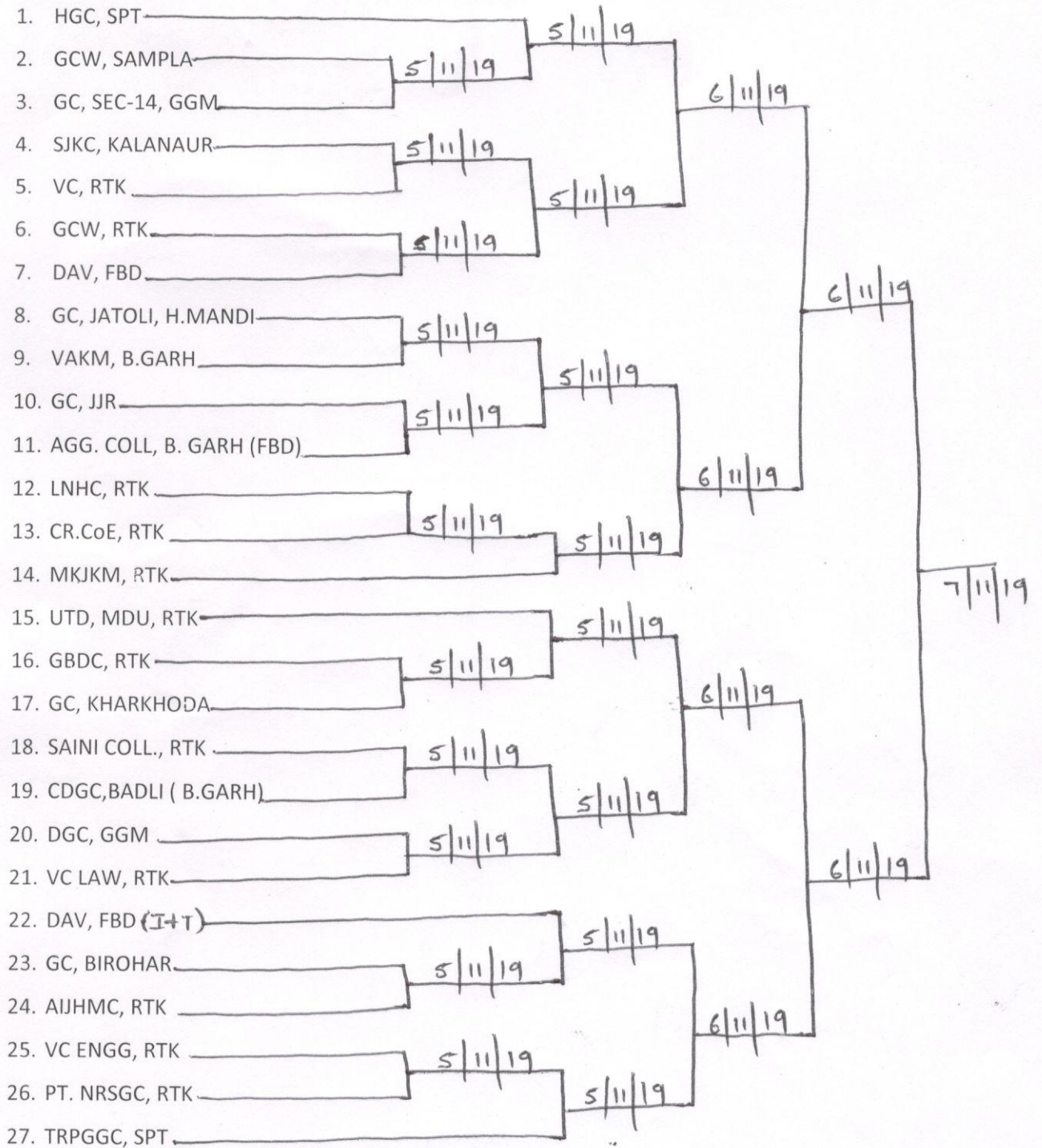

.Match for 3rd & 4th Position will be played on 07.11.19 at 9 AM.

.Selection trials for Uni. Team on 07.11.19 at 01 PM , Sports Complex, MDU, Rohtak

Fixture for Kho-Kho (W) scheduled at Sports Complex, Rohtak ✓

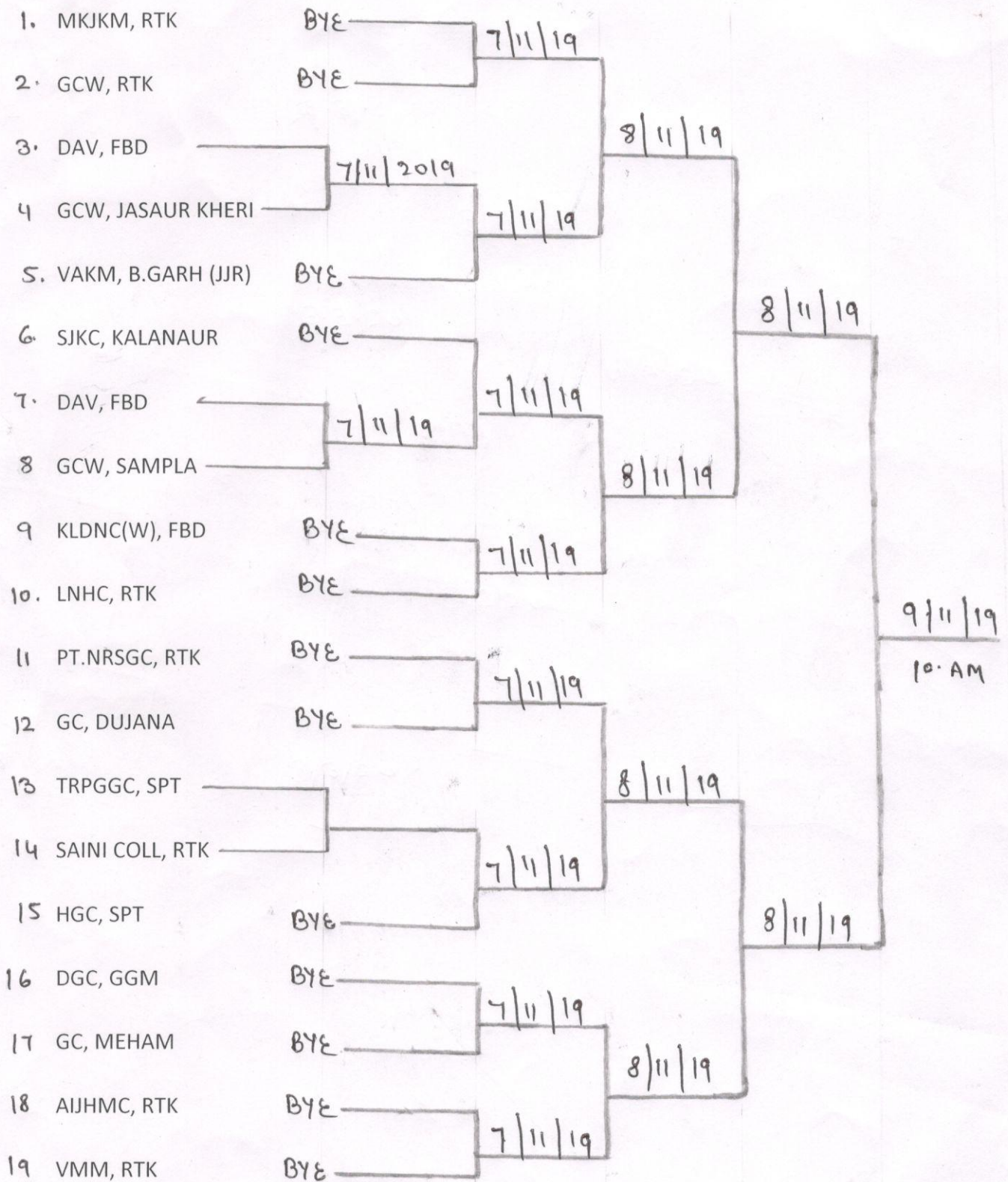

.Match for 3rd and 4th Position will be played on 09.11.19 at 9 AM

.Selection trials for MDU team will be held on 09.11.19 at 11AM, Sports Complex, MDU, Rohtak

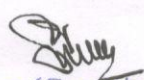
 Director (Sports)
 M.D. University
 ROHTAK